

# SFM60-H1BB4K02

SFS/SFM60

MOTOR FEEDBACK SYSTEMS ROTARY HIPERFACE®

**SICK**  
Sensor Intelligence.

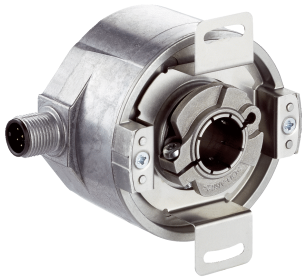

Illustration may differ



### Ordering information

Type	Part no.
SFM60-H1BB4K02	On request

Other models and accessories → [www.sick.com/SFS\\_SFM60](http://www.sick.com/SFS_SFM60)

### Detailed technical data

#### Performance

<b>Number of sine/cosine periods per revolution</b>	1,024
<b>Number of the absolute ascertainable revolutions</b>	4,096
<b>Total number of steps</b>	134,217,728
<b>Measuring step</b>	0.3 Winkelsekunden For interpolation of the sine/cosine signals with, e. g., 12 bits
<b>Integral non-linearity</b>	± 45 Winkelsekunden, Error limits for evaluating sine/cosine period, without mechanical tension of the stator coupling
<b>Differential non-linearity</b>	± 7 Winkelsekunden, Non-linearity within a sine/cosine period
<b>Operating speed</b>	6,000 min <sup>-1</sup> , up to which the absolute position can be reliably produced

#### Interfaces

<b>Type of code for the absolute value</b>	Binary
<b>Code sequence</b>	Rising, For clockwise shaft rotation, looking in direction "A" (see dimensional drawing)
<b>Communication interface</b>	HIPERFACE®
<b>Available memory area</b>	1,792 Byte

#### Electrical data

<b>Supply voltage range</b>	7 V DC ... 12 V DC
<b>Recommended supply voltage</b>	8 V DC
<b>Operating power consumption (no load)</b>	< 80 mA <sup>1)</sup>
<b>Output frequency for sine/cosine signals</b>	0 kHz ... 200 kHz

<sup>1)</sup> Without load.

#### Mechanical data

<b>Shaft version</b>	Blind hollow shaft
<b>Shaft material</b>	Stainless steel
<b>Flange material</b>	Zinc diecast
<b>Housing material</b>	Aluminum die cast

<sup>1)</sup> Take into account self-heating of 3.3 K per 1,000 rpm when designing the operating temperature range.

<b>Flange type / stator coupling</b>	Stator coupling
<b>Dimensions</b>	See dimensional drawing
<b>Weight</b>	≤ 0.25 kg
<b>Moment of inertia of the rotor</b>	40 gcm <sup>2</sup>
<b>Operating speed</b>	≤ 9,000 min <sup>-1</sup> <sup>1)</sup>
<b>Angular acceleration</b>	≤ 500,000 rad/s <sup>2</sup>
<b>Operating torque</b>	0.6 Ncm (+20 °C)
<b>Start up torque</b>	0.8 Ncm (+20 °C)
<b>Permissible shaft movement, radial static/dynamic</b>	± 0.3 mm / ± 0.1 mm
<b>Permissible shaft movement, axial static/dynamic</b>	± 0.5 mm / ± 0.2 mm
<b>Life of ball bearings</b>	3.6 x 10 <sup>9</sup> revolutions
<b>Connection type</b>	Male connector M12, 8-pin, radial

<sup>1)</sup> Take into account self-heating of 3.3 K per 1,000 rpm when designing the operating temperature range.

### Ambient data

<b>Operating temperature range</b>	-40 °C ... +115 °C
<b>Storage temperature range</b>	-40 °C ... +115 °C, without package
<b>Relative humidity/condensation</b>	90 %, Condensation not permitted
<b>Resistance to shocks</b>	100 g, 6 ms (according to EN 60068-2-27)
<b>Frequency range of resistance to vibrations</b>	20 g, 10 Hz ... 2,000 Hz (according to EN 60068-2-6)
<b>EMC</b>	According to EN 61000-6-2 and EN 61000-6-3 <sup>1)</sup>
<b>Enclosure rating</b>	IP65, with mating connector inserted (according to IEC 60529)

<sup>1)</sup> The EMC according to the standards quoted is achieved when the motor feedback system is mounted in an electrically conductive housing, which is connected to the central earthing point of the motor controller via a cable screen. The GND-(0 V) connection of the supply voltage is also grounded here. If other shielding concepts are used, users must perform their own tests.

### Classifications

<b>ECl@ss 5.0</b>	27270590
<b>ECl@ss 5.1.4</b>	27270590
<b>ECl@ss 6.0</b>	27270590
<b>ECl@ss 6.2</b>	27270590
<b>ECl@ss 7.0</b>	27270590
<b>ECl@ss 8.0</b>	27270590
<b>ECl@ss 8.1</b>	27270590
<b>ECl@ss 9.0</b>	27270590
<b>ETIM 5.0</b>	EC001486
<b>ETIM 6.0</b>	EC001486
<b>UNSPSC 16.0901</b>	41112113

**Dimensional drawing** (Dimensions in mm (inch))

Blind hollow shaft, male connector connection - standard system

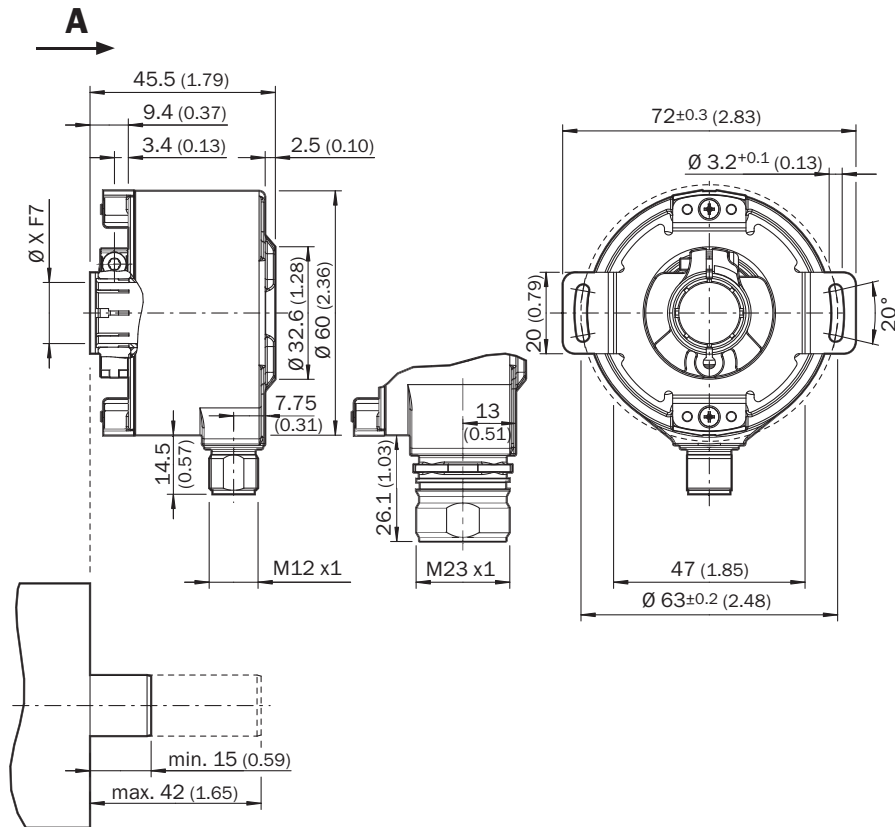

General tolerances according to DIN ISO 2768-mk

**Proposed fitting**

Version 4

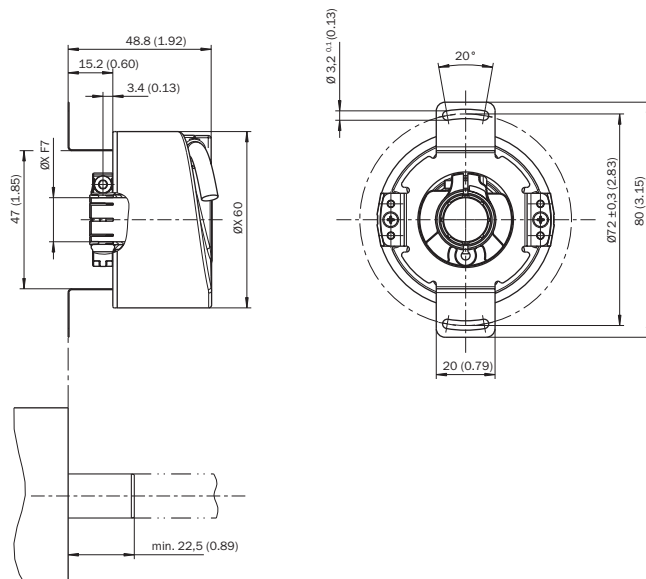

### PIN assignment

View of the M12 male connector plug-in face

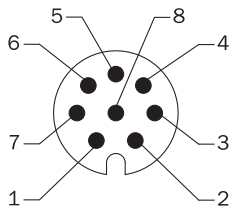

PIN	Signal	Explanation
1	REFSIN	Process data channel
2	+ SIN	Process data channel
3	REFCOS	Process data channel
4	+ COS	Process data channel
5	Data +	Parameter channel RS 485
6	Data -	Parameter channel RS 485
8	U <sub>S</sub>	Supply voltage
Housing	Screen	Screen connected with encoder housing

### Diagram

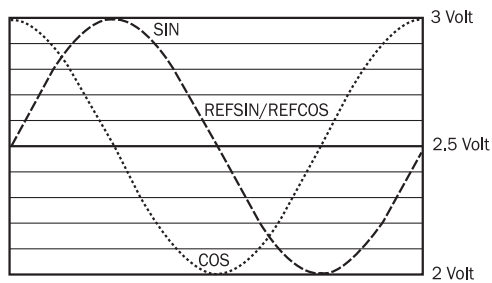

Signal specification of the process channel



Signal diagram for clockwise rotation of the shaft looking in direction "A" (see dimensional drawing) 1 period = 360 ° : 1024

### Recommended accessories

Other models and accessories → [www.sick.com/SFS\\_SFM60](http://www.sick.com/SFS_SFM60)

	Brief description	Type	Part no.
<b>Flanges</b>			
	Stator coupling, 16.5 mm high	BEF-DS05XFX	2057423
	Stator coupling with hole circle diameter 63 mm	BEF-DS07XFX	2059368

	<b>Brief description</b>	<b>Type</b>	<b>Part no.</b>
Programming and configuration tools			
	SVip® LAN programming tool for all motor feedback systems	PGT-11-S LAN	1057324
	SVip® WLAN programming tool for all motor feedback systems	PGT-11-S WLAN	1067474

## SICK AT A GLANCE

SICK is one of the leading manufacturers of intelligent sensors and sensor solutions for industrial applications. A unique range of products and services creates the perfect basis for controlling processes securely and efficiently, protecting individuals from accidents and preventing damage to the environment.

We have extensive experience in a wide range of industries and understand their processes and requirements. With intelligent sensors, we can deliver exactly what our customers need. In application centers in Europe, Asia and North America, system solutions are tested and optimized in accordance with customer specifications. All this makes us a reliable supplier and development partner.

Comprehensive services complete our offering: SICK LifeTime Services provide support throughout the machine life cycle and ensure safety and productivity.

For us, that is “Sensor Intelligence.”

## WORLDWIDE PRESENCE:

Contacts and other locations –[www.sick.com](http://www.sick.com)